

PIPE CLIP

(WHABS004 - 25/27mm)



BISSON
THE PIPE FITTINGS EXPERTS

Aspirating smoke detection pipe clip, designed to support both 25 and 27mm smoke pipe, in either ABS, PVC, or CPVC polymers. The clip has a flexible side wall which allows the clip to open wide enough to allow the pipe to be placed within it's circular cavity. The clip secures the pipe when closed. Slight discolouration may appear on the side wall, after repeated opening and closing. This does not affect the clips performance.

Installation Instructions:

For use to fix to any surface (wall, ceiling, floor etc) or for use with a threaded rod adaptor if the installation requires the pipe to be hung below the ceiling. (please note the adaptor is a separate item available from Bisson, the code is WAL 0854359 SQ10-SQ32.) Do not install in direct sunlight. Pipe clips are required at a maximum of 800mm along the length of pipe at ambient temperatures. (-5 up to +30 degrees C) This should be reduced to a maximum of 600mm at temperatures above 30 degrees centigrade. Only install with approved fittings, and pipe that conforms to the European standard EN54 part 20.

Do not use solvents to clean, only soapy water. When ambient temperatures are outside 15-25C use pipe expansion joints

The clips are made from polypropylene and therefore should NOT be installed where the temperatures are lower than -5 degree C particularly in cold or chill stores. The upper limit is +70 degrees C, the clip allows for the movement of pipe to expand or contract to ambient temperatures.

RAW MATERIAL DATA

Raw Material
Polypropylene

UVA/UVB
Not stable in UVA/UVB sunlight, which will degrade the material

Hardness
Rockwell hardness 103 test method ASTM D785

Flammability
Flame rating 0.0630 in 160mm HB test method UL94

Temperature range -5 up to +70 degrees C



PART NO.:
WHABS004

PIPE COLOUR:
White

DIAMETER TOLERANCE:
+ / - 0.15mm¹

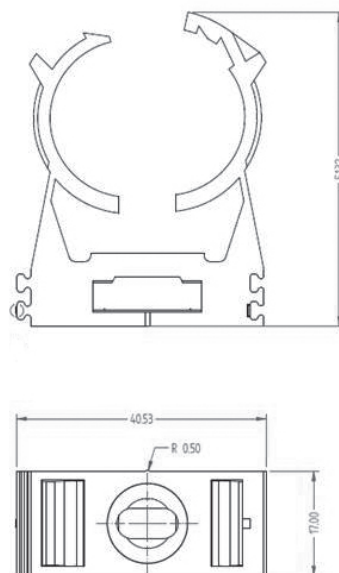
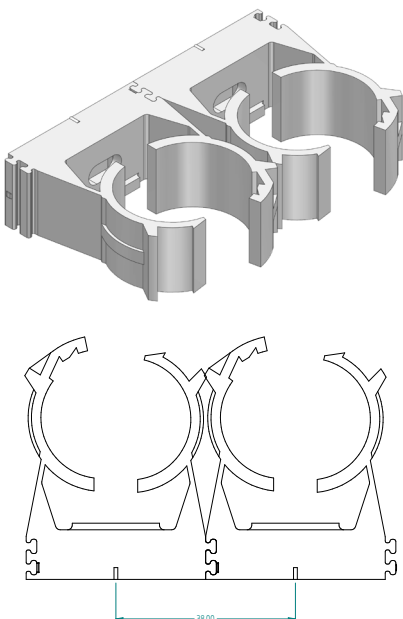

Threaded Rod Adaptor
WAL 0854359 SQ10-SQ32

